



D

DESCRIPTION

The Gamma Series of centrifugal roof units has been designed for use in commercial ducted exhaust applications. These compact and low profile units are fitted with birdmesh to prevent the entry of birds and vermin into the ducting or building. They are available in 12 sizes, extending from 192 to 710mm diameter.

Typical Applications

Exhaust air from a wide range of commercial applications such as factories, warehouses and workshops, change rooms, bulk goods retail outlets and assembly halls.

Features

- Robust, lightweight construction.
- Choice of speeds available.
- Compact, low profile design.
- Designed for down flow or vertical discharge applications.
- Twin vertical discharge fan also available. Provides 100% standby capacity.
- Shutters are standard on twin fan units and an optional extra for single fan units. The pressure loss across the shutter has to be added to the system pressure before making selections.
- Can be mounted at angle up to 30°.
- Most 3-phase motors are 2-speed star/delta design.
- Supply air units can be supplied, see pages D-32/33 for selection data.

Construction

Cowls are UV-stabilised plastic.

Impellers are backward-curved centrifugal design and can be plastic, steel or aluminium.

Steel components have a corrosion resistant finish.

Bird-mesh guards are fitted as standard to both downflow and vertical exhaust models.

Motors

Type - external rotor, squirrel cage induction motor

Electricity supply - 230V, single and 415V, three-phase, 50Hz

Bearings - sealed-for-life, ball

Speed-controllable using electronic or auto-transformer controllers (except CE316)

Most three-phase units are fitted with 2-speed star/delta design motors

See page O-2/3 for details on these motors

Internal Thermal Protection

Thermal protection is supplied as standard on all motors.

BACKDRAFT DAMPER LOSSES

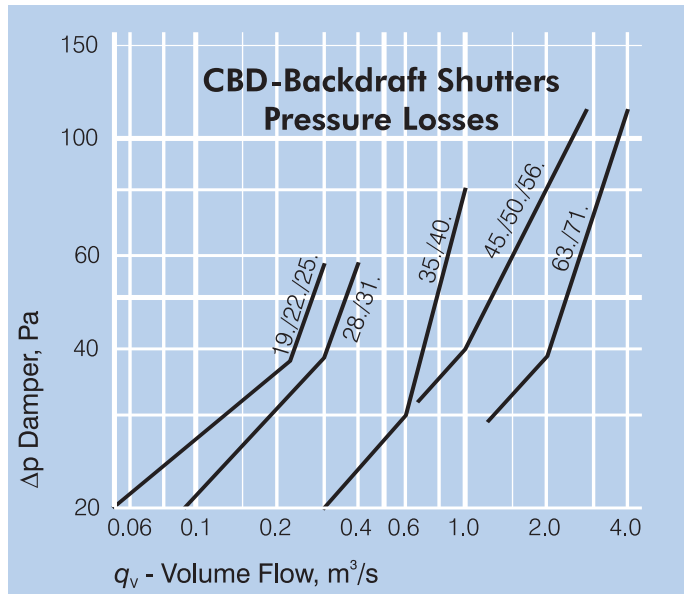

Refer to page J-2 for more information on this product.

Testing

Air flow tests to ISO5801:2007

Noise tests to BS848:Part 2, 1985

Wiring Diagram

See page N-8, diagram ER 1, 2, 4, 5.

HOW TO ORDER

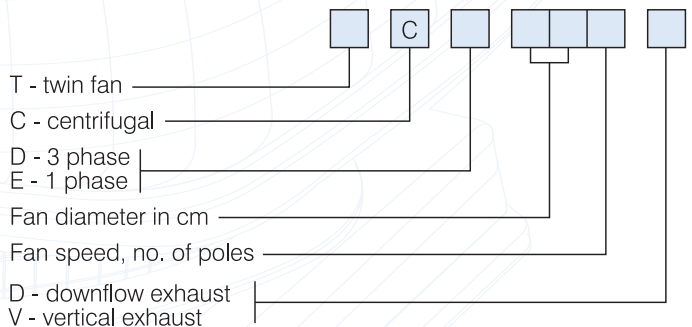

TECHNICAL DATA

Model CD...D/V CE...D/V	Nom. Speed r/s	Inlet	Avg dB(A) @ 3m		CE..1 ph.		CD..3 ph.		In-duct Spectrum Corrections, dB**							
			Low Air Flow	High Air Flow	kW	Amps*	kW	Amps*	63	125	250	500	1k	2k	4k	8k
192.	42	Inlet	45	47	0.07	0.30	-	-	21	22	22	19	12	11	9	2
224.	23	Inlet	38	39	0.05	0.26	-	-	29	27	22	19	11	11	9	3
252.	42	Inlet	56	58	0.19	0.83	-	-	27	22	20	19	12	11	10	2
254.	23	Inlet	41	42	0.08	0.37	-	-	30	28	22	19	11	11	9	3
284.	23	Inlet	44	45	0.09	0.40	-	-	31	28	22	19	11	11	9	3
314.	23	Inlet	47	48	0.15	0.66	0.18	0.37	35	29	21	18	10	10	8	2
316.†	15	Inlet	40	42	0.07	0.54	0.09	0.15	34	26	22	18	12	12	6	0
354.	23	Inlet	52	51	0.28	1.25	0.19	0.51	28	26	22	19	10	12	11	1
356.	15	Inlet	43	43	0.07	0.32	0.13	0.22	33	25	22	19	14	8	3	0
404.	23	Inlet	56	54	0.49	2.20	0.45	1.40	28	26	21	18	11	12	12	5
406.	15	Inlet	44	44	0.17	0.80	0.23	0.73	33	28	22	19	14	10	7	3
408.	11	Inlet	39	40	-	-	0.16	0.30	33	26	19	16	14	14	12	3
454.	23	Inlet	59	57	0.76	3.50	0.77	1.47	27	25	20	17	11	12	12	8
456.	15	Inlet	47	46	0.43	2.00	0.44	0.90	31	30	21	18	13	11	9	5
458.	11	Inlet	41	43	-	-	0.15	0.35	33	26	19	16	14	14	12	3
504.	23	Inlet	62	61	1.30	5.70	1.39	2.70	26	26	21	15	12	12	12	9
506.	15	Inlet	50	50	0.53	2.50	0.65	1.20	30	29	22	16	12	10	8	6
508.	11	Inlet	43	45	0.23	1.15	0.30	0.50	32	26	20	16	14	13	12	4
564.	23	Inlet	65	65	-	-	2.16	4.10	26	27	23	14	13	12	12	10
566.	15	Inlet	54	54	0.84	4.10	0.69	1.45	29	29	23	15	12	10	8	7
568.	11	Inlet	44	47	0.32	1.50	0.39	0.79	30	27	22	15	15	11	11	6
634.	23	Inlet	69	70	-	-	4.30	7.35	24	28	24	12	13	11	12	10
636.	15	Inlet	60	58	-	-	1.10	2.20	28	29	24	14	12	10	8	8
638.	11	Inlet	46	50	-	-	0.68	1.20	28	27	23	14	14	9	10	6
716.	15	Inlet	63	61	-	-	2.20	4.30	28	29	24	14	12	10	8	8
718.	11	Inlet	48	53	-	-	0.66	2.00	28	27	23	14	14	9	10	6
711.	9	Inlet	41	46	-	-	0.28	1.20	28	27	23	14	14	9	10	6

Electrical data in **bold** type refers to fans fitted with 2-speed star/delta motors as standard.

* Amperages shown are a guide only, refer to our Sales Department for accurate figures at time of order.

** Add the In-Duct Spectrum Corrections to the closest dB(A) level shown on the fan curve to obtain the In-Duct Sound Power Levels on the Inlet Side of the unit.

† The CE316. model is not speed-controllable.

DIMENSIONS

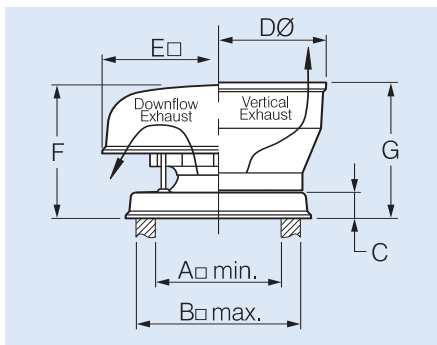

Single Fan Units

Model No. CD... CE...	Dimensions, mm							Approx. weight kg.	Approx. volume m³
	A□	B□	C	DØ	E□	F	G		
192-254	260	310	50	430	370	200	244	4	0.05
284-316	310	410	75	500	575	330	334	8	0.13
354-408	400	500	75	640	670	410	417	18	0.22
454-568	620	720	75	908	890	530	540	38	0.52
634-711	710	810	75	1260	1180	650	695	69	1.28

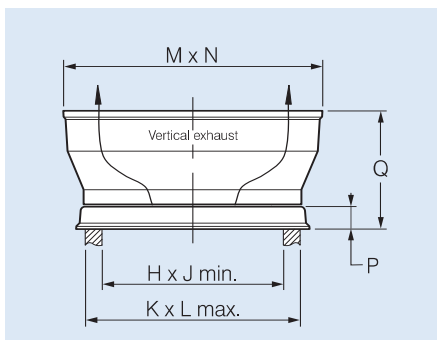

Twin Fan Units

Model No. TCD... TCE...	Dimensions, mm								Approx. weight kg.	Approx. volume m³
	H	J	K	L	M	N	P	Q		
252-254	600	260	650	310	770	430	50	244	8	0.10
314-316	700	310	800	410	892	500	75	334	16	0.18
354-408	900	400	1000	500	1196	640	75	417	36	0.37
454-568	1330	620	1430	720	1630	908	75	540	76	0.92

GAMMA SERIES

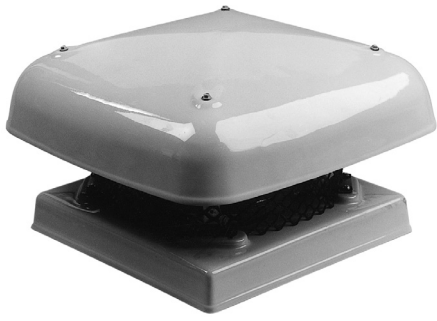

SUGGESTED SPECIFICATION

Downflow Exhaust Series

The Gamma Series of centrifugal roof ventilators shall be the downflow exhaust type as designed and manufactured by Fantech Pty. Ltd.

Impellers shall be backward-curved centrifugal design and driven by speed-controllable external rotor motors with integral thermal protection.

The cowl shall be of the downflow exhaust design and formed from plastic and/or fibreglass. Steel components are corrosion protected.

All models shall be fully tested as a complete assembled unit to ISO5801:2007 for air flow and BS848:Part 2, 1985 for noise.

ANCILLARY EQUIPMENT

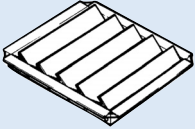
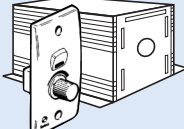
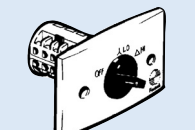
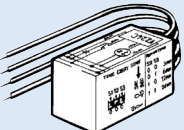
	
CBD - Backdraft shutter Ref. J-2	Speed controllers Ref. M-1
	
SD - Star/Delta switch Ref. M-7	VZ - Run-on timer Ref. M-14



Scan the QR Code to view more information online.

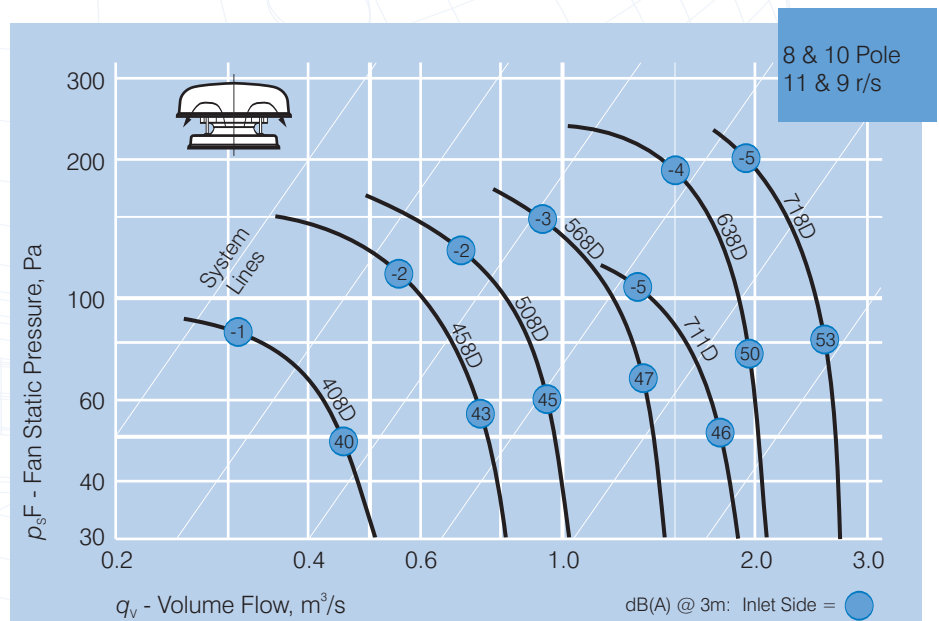
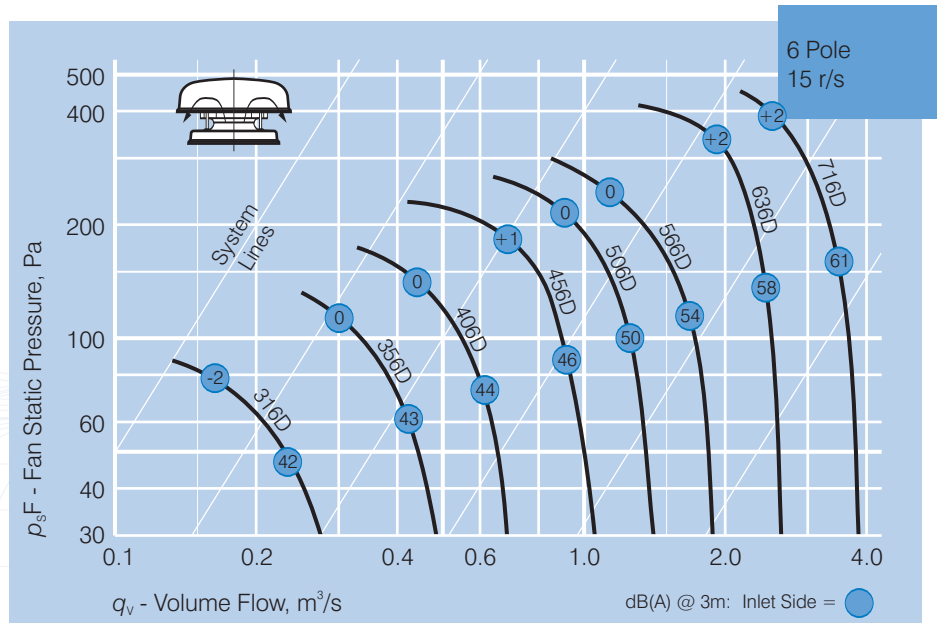
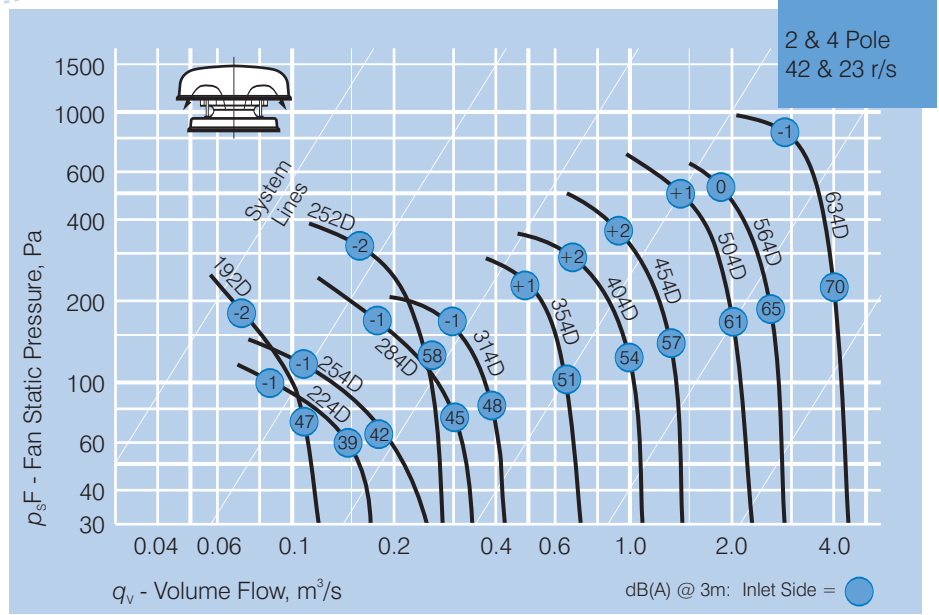



SUGGESTED SPECIFICATION

Vertical Exhaust Series

The Gamma Series of centrifugal roof ventilators shall be of the vertical exhaust type as designed and manufactured by Fantech Pty. Ltd.

Impellers shall be backward-curved centrifugal design and driven by speed-controllable external rotor motors with integral thermal protection.

The windband shall be of the vertical exhaust design and formed from plastic. Steel components shall be corrosion protected.

All models shall be fully tested as a complete assembled unit to ISO5801:2007 for air flow and BS848:Part 2, 1985 for noise.

ANCILLARY EQUIPMENT

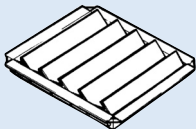
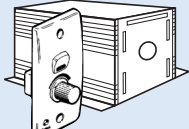
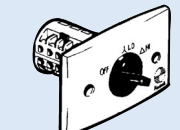
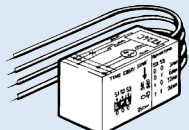
 <p>CBD - Backdraft shutter Ref. J-2</p>	 <p>Speed controllers Ref. M-1</p>
 <p>SD - Star/Delta switch Ref. M-7</p>	 <p>VZ - Run-on timer Ref. M-14</p>



Scan the QR Code to view more information online.

