

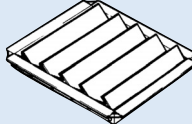

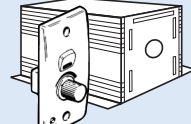

## ANCILLARY EQUIPMENT

 CBD - Backdraft shutter Ref. J-2	 Speed controllers Ref. M-1	 VA - Speed controller Ref. M-5
 SD - Star/Delta switch Ref. M-7	 VZ - Run-on timer Ref. M-14	

## DESCRIPTION

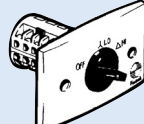
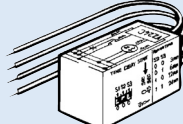
The GL Gamma Series of centrifugal roof units feature a removable windband that provides easy access for cleaning and maintenance. These compact, low profile fans are suited for ducted exhaust applications and are available in 8 sizes extending from 315 to 710mm diameter.

## Typical Applications

Designed for use in commercial kitchen exhaust installations as well as applications requiring vertical discharge and all metal construction.

## Features

- Robust, galvanised steel construction.
- Fitted with a high performance backward-curved centrifugal fan.
- Choice of speeds available.
- Quick release toggle clamps provide easy access for cleaning and maintenance.
- Speed-controllable with electronic or auto-transformer controllers (not on CE316VGL).
- Many 3-phase motors are 2-speed star/delta design
- Can be mounted at angles up to 30°.

## Construction

Cowls are of galvanised steel construction  
Backward-curved centrifugal impellers  
Bird-mesh guards are an optional extra  
Powder-coating is an optional extra

## Motors

Type - external rotor, squirrel cage induction motors  
Electricity supply - 230V, single and 415V, three-phase, 50Hz  
Bearings - sealed-for-life, ball  
Speed-controllable using electronic or auto-transformer controllers (not CE316VGL)  
Many 3-phase motors are 2-speed, star/delta design.  
See pages O-2/3 for detail on these motors.

## Internal Thermal Protection

All motors are fitted with Internal Thermal Contacts as standard.

## Testing

Air flow tests to ISO5801:1997  
Noise tests to BS848:Part 2, 1985

## Wiring Diagram

See page N-8, diagrams ER 1, 2, 4, 5.

## Special Notes

Backdraft shutters are an optional extra, refer to page J-2 for details. The pressure loss across the shutter has to be added to the system pressure before making fan selections.

## Kitchen Hood Exhaust Systems

AS1668.1:1998 Clause 11.2.5 states that, for commercial installations, Kitchen Exhaust fan casings and cowls shall be manufactured from non-combustible materials that have a fusing temperature above 1000°C.

## SUGGESTED SPECIFICATIONS

The roof ventilators shall be of the GL Gamma Series vertical discharge type as designed and manufactured by Fantech Pty Ltd.

Impellers shall be backward-curved centrifugal design and driven by speed-controllable external rotor motors with integral thermal protection.

The cowls shall be of the vertical discharge design and manufactured from galvanised steel. Steel components to be corrosion protected.

All data shall be based on tests on a complete assembled unit to ISO5801:1997 for air flow and BS848:Part 2, 1985 for noise.

## HOW TO ORDER

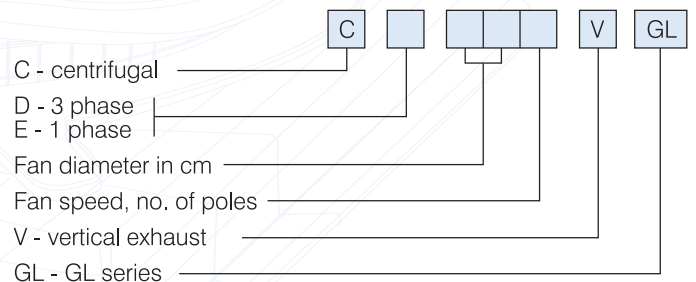

## TECHNICAL DATA & NOISE LEVELS

Model CD...VGL CE...VGL	Nom. Speed r/s	Inlet	Avg dB(A) @ 3m		CE.. 1 ph.		CD.. 3 ph.		In-duct Spectrum Corrections, dB**							
			Low Air Flow	High Air Flow	kW	Amps*	kW	Amps*	63	125	250	500	1k	2k	4k	8k
314.	23	Inlet	47	48	0.15	0.66	<b>0.18</b>	<b>0.37</b>	35	29	21	18	10	10	8	2
316.†	15	Inlet	40	42	0.07	0.54	0.09	0.15	34	26	22	18	12	12	6	0
354.	23	Inlet	52	51	0.28	1.25	<b>0.19</b>	<b>0.51</b>	28	26	22	19	10	12	11	1
356.	15	Inlet	43	43	0.07	0.32	0.13	0.22	33	25	22	19	14	8	3	0
404.	23	Inlet	56	54	0.49	2.20	<b>0.45</b>	<b>1.40</b>	28	26	21	18	11	12	12	5
406.	15	Inlet	44	44	0.17	0.80	<b>0.23</b>	<b>0.73</b>	33	28	22	19	14	10	7	3
408.	11	Inlet	39	40	-	-	0.16	0.30	33	26	19	16	14	14	12	3
454.	23	Inlet	59	57	0.76	3.50	<b>0.77</b>	<b>1.47</b>	27	25	20	17	11	12	12	8
456.	15	Inlet	47	46	0.43	2.00	<b>0.44</b>	<b>0.90</b>	31	30	21	18	13	11	9	5
458.	11	Inlet	41	43	-	-	0.15	0.35	33	26	19	16	14	14	12	3
504.	23	Inlet	62	61	1.30	5.70	<b>1.39</b>	<b>2.70</b>	26	26	21	15	12	12	12	9
506.	15	Inlet	50	50	0.53	2.50	<b>0.65</b>	<b>1.20</b>	30	29	22	16	12	10	8	6
508.	11	Inlet	43	45	0.23	1.15	0.30	0.50	32	26	20	16	14	13	12	4
564.	23	Inlet	65	65	-	-	<b>2.16</b>	<b>4.10</b>	26	27	23	14	13	12	12	10
566.	15	Inlet	54	54	0.84	4.10	<b>0.69</b>	<b>1.45</b>	29	29	23	15	12	10	8	7
568.	11	Inlet	44	47	0.32	1.50	0.39	0.79	30	27	22	15	15	11	11	6
634.	23	Inlet	69	70	-	-	<b>4.30</b>	<b>7.35</b>	24	28	24	12	13	11	12	10
636.	15	Inlet	60	58	-	-	<b>1.10</b>	<b>2.20</b>	28	29	24	14	12	10	8	8
638.	11	Inlet	46	50	-	-	0.68	1.20	28	27	23	14	14	9	10	6
716.	15	Inlet	63	61	-	-	<b>2.20</b>	<b>4.30</b>	28	29	24	14	12	10	8	8
718.	11	Inlet	48	53	-	-	<b>0.66</b>	<b>2.00</b>	28	27	23	14	14	9	10	6
711.	9	Inlet	41	46	-	-	0.28	1.20	28	27	23	14	14	9	10	6

Electrical data in **bold** type refers to fans fitted with 2-speed star/delta motors as standard.

\* Amperages shown are a guide only, refer to our Sales Department for accurate figures at time of order.

\*\* Add the In-Duct Spectrum Corrections to the closest dB(A) level shown on the fan curve to obtain the In-Duct Sound Power Levels on the Inlet Side of the unit.

† The CE316VGL is not speed controllable.

## DIMENSIONS

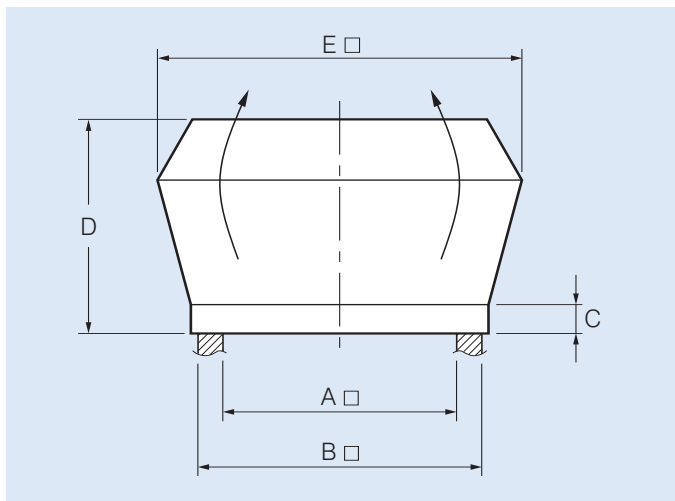

Model CD...VGL CE...VGL	A	B	C	D	E	Approx. weight kg.	Approx. volume m³
314							
316	310	410	50	310	520	16	0.10
354							
356	400	500	50	420	670	26	0.22
404							
406	400	500	50	420	670	26	0.22
408							
454							
456	620	720	60	525	900	49	0.50
458							
504						57	
506	620	720	60	525	900	51	0.50
508							
564						65	
566	620	720	60	525	900	56	0.50
568							
634						97	
636	710	810	60	665	1160	78	1.03
638							
716						95	
718	710	810	60	665	1160	83	1.03
711							



Scan the QR Code  
to view wiring  
diagrams or more  
information online.



# GL GAMMA SERIES

## Note

Performance curves shown are based on nominal speeds.

As motor speeds may vary from one manufacturer to another, and from one motor type to another, variations in performance can result.

