



## DESCRIPTION

The Mixvent Series is a high performance, low profile and compact in-line mixed-flow fans.

With 7 models in the Series they match standard duct sizes from 100 to 315mm diameter. Suitable for mounting in any position.

## Typical Applications

Designed for the ventilation of toilets, bathrooms, ensuites, laundries and kitchens in homes, hotels, apartments and commercial buildings. Suitable for both supply and exhaust air applications and the transfer of warm and cool air from one room to another.

## Features

- High performance mixed-flow impeller.
- Fans can be easily removed for maintenance or repair without disturbing the duct system via specially designed support brackets.
- All models are designed for direct connection to standard diameter circular ducting.
- A mounting foot is incorporated into the fan housing design which assists with installation.
- Includes plug and lead for easy installation.
- Wired in high speed.

## Construction

The housings of models 250/100 to 800/200 are of reinforced, moulded polypropylene plastic. Models 1300/250 and 2000/315 are of epoxy coated steel.

The mixed-flow impellers are of injection moulded plastic.

## Motors

Type - 2-speed squirrel cage, capacitor run.

Electricity supply - 230V, single-phase, 50/60Hz.

Bearings - sealed for life, ball.

Speed-controllable using VA type speed controllers in high speed only.

Class B insulation, IP44.

See pages O-3/4 for details on the motors.

## Internal Thermal Protection

By fuse to size 350/125 and for all other models manual-reset thermal overload protection device in accordance with mandatory requirement for in-duct fans AS/NZS60335-2-80:2004.

## Testing

Air flow to ISO5801: Part 1, 1997 and AMCA 210-99.

Noise to BS848:Part 2, 1985







## Special Note

Avoid the use of spring-loaded backdraft dampers, extensive lengths of duct and air valves with the TD-250/100 and TD-350/125 models.

## Multi-stage fans

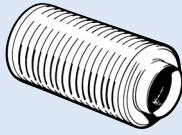
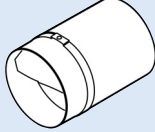
In addition to being used as single-stage fans, the Mixvent range can be arranged in parallel, in series or in both parallel and series. Such flexibility enables higher air flow and pressure demands to be met. Details for 2-stage parallel are shown over-page; refer to the Fans by Fantech Product Selection Program for details of other combinations.

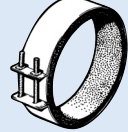
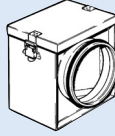
## ANCILLARY EQUIPMENT

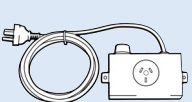
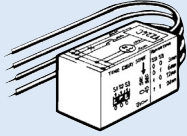
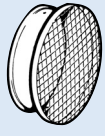
 RED - Reducer* Ref. B-17	 TSS1 - 2-Speed switch Ref. B-17	 CC - Attenuators Ref. H-16
 SJK - Backdraft Damper Ref. J-3	 RSK - Backdraft Dampers Ref. J-3	 FC - Fast clamp Ref. J-5
 FGR - Filter Unit Ref. J-10	 VA - Speed controller Ref. M-5	 Plug-In Run-on Timer and Speed Controller Ref. Section M-16
 VZ - Run-on timer Ref. M-14	 MRJ - Inlet grille Ref. J-9	

\* If it is necessary to connect the TD-2000/315 unit to 300mm diameter ducting it is recommended 2-RED031-030 reducers be used. In this situation the performance will be reduced by approximately 7%.

## SUGGESTED SPECIFICATION

The In-line fans shall be of the Mixvent Series as supplied by Fantech Pty. Ltd and be of the model numbers shown on the schedule/drawing.

Impellers shall be of mixed-flow design and driven by 2-speed single-phase motors. Internal thermal protection shall be by fuse on sizes up to 350/125 and by manual reset on all other models.

All fans shall be tested in accordance with ISO5801:Part 1 1997 or AMCA 210-99 for air flow and BS848:Part 2, 1985 for noise.

## TECHNICAL DATA

Model Number	Fan Speed rev/sec	Avg. dB(A) @ 3m	TD.. 1 ph. Watts	Amps	Max. amb °C	App. wt. kg
250/100	37 / 31	36 / 32	24 / 18	0.11 / 0.10	40	2.0
350/125	38 / 32	37 / 39	30 / 22	0.13 / 0.10	40	2.0
500/150	42 / 33	45 / 38	50 / 44	0.22 / 0.19	60	2.7
800/200N	46 / 41	50 / 39	95 / 90	0.45 / 0.43	60	4.9
800/200	42 / 33	51 / 44	120 / 100	0.50 / 0.45	60	4.9
1300/250	42 / 33	57 / 49	180 / 140	0.80 / 0.60	60	9.4
2000/315	45 / 33	59 / 55	255 / 160	1.20 / 0.80	60	14.0

Values shown are High Speed / Low Speed

## HOW TO ORDER

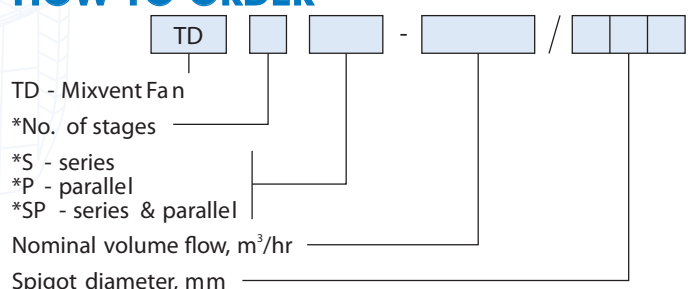

\* Only required if other than standard single-stage unit.

## SINGLE-STAGE

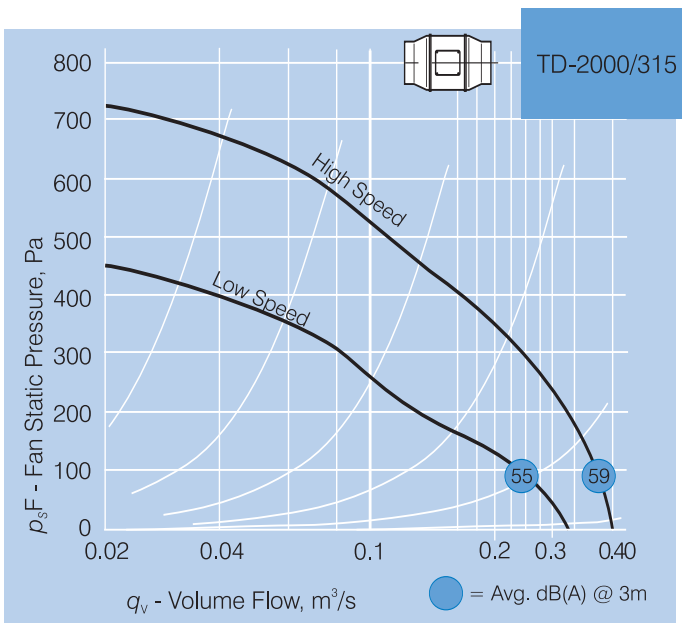
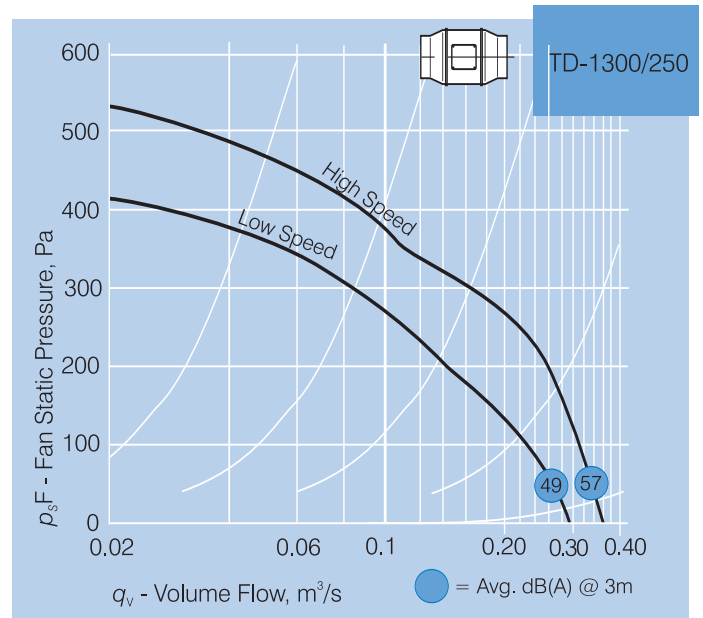
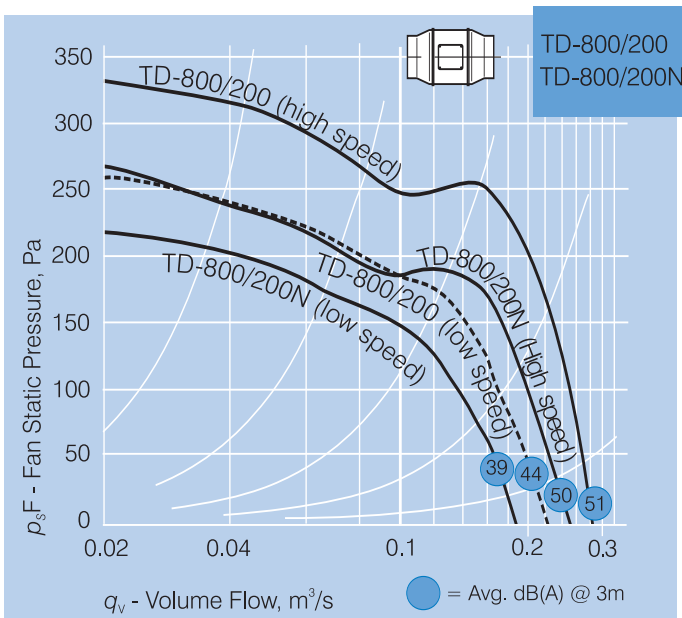
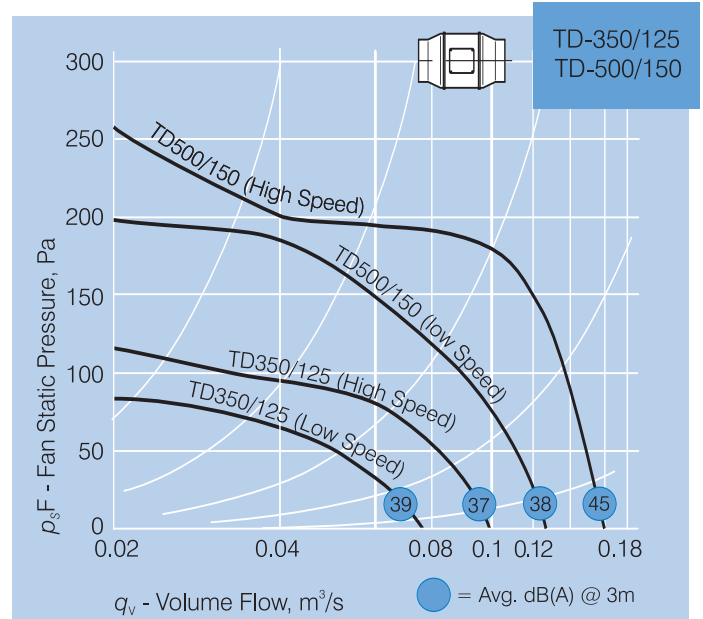
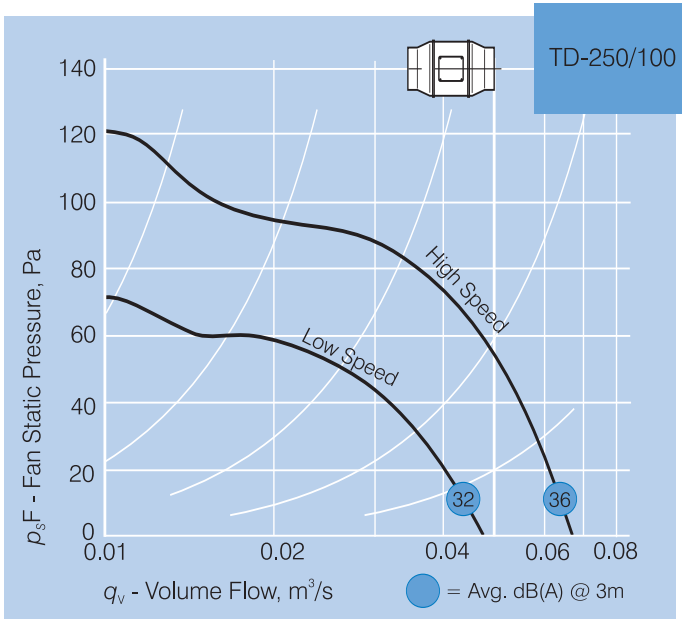

# MIXVENT SERIES

## NOISE DATA

Model Number TD-...		Avg. dB(A) @ 3m	In-duct Sound Power Levels $L_w$ dB re 1pW							
			63	125	250	500	1k	2k	4k	8k
250/100	Inlet	36	54	63	55	56	52	48	40	32
	Breakout	30	53	62	54	47	43	44	33	24
350/125	Inlet	37	61	63	55	56	54	51	42	32
	Breakout	32	59	62	55	50	47	46	34	23
500/150	Inlet	45	58	51	64	60	59	63	57	47
	Breakout	33	51	48	52	42	44	54	43	28
800/200N	Inlet	50	63	58	71	67	66	65	61	51
	Breakout	36	52	48	57	50	52	54	45	30
800/200	Inlet	51	63	63	70	66	68	68	65	53
	Breakout	39	55	52	56	49	54	58	49	32
1300/250	Inlet	57	63	68	73	70	75	74	67	60
	Breakout	42	48	52	48	50	60	60	53	46
2000/315	Inlet	59	67	73	75	74	77	75	68	61
	Breakout	47	55	57	61	58	64	64	58	52

Sound Power Levels shown are based on the high speed for each fan.

## DIMENSIONS

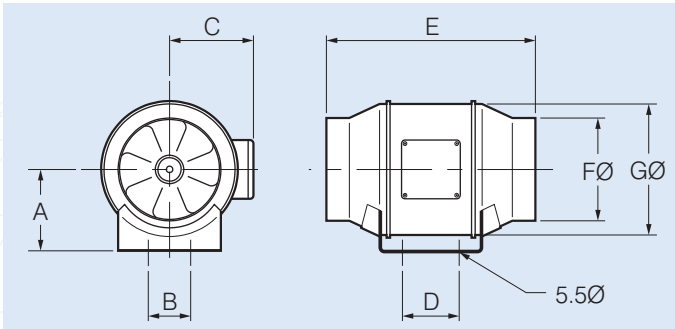

Model No. TD-..	Dimensions, mm						
	A	B	C	D	E	FØ	GØ
250/100	100	60	115	80	303	97	176
350/125	100	60	115	80	258	123	176
500/150	112	60	127	80	295	147	200
800/200&N	124	94	141	100	302	198	217
1300/250	155	140	192	145	386	248	272
2000/315	188	178	224	182	450	312	336



Scan the QR Code to view more information online.



## FANS IN PARALLEL

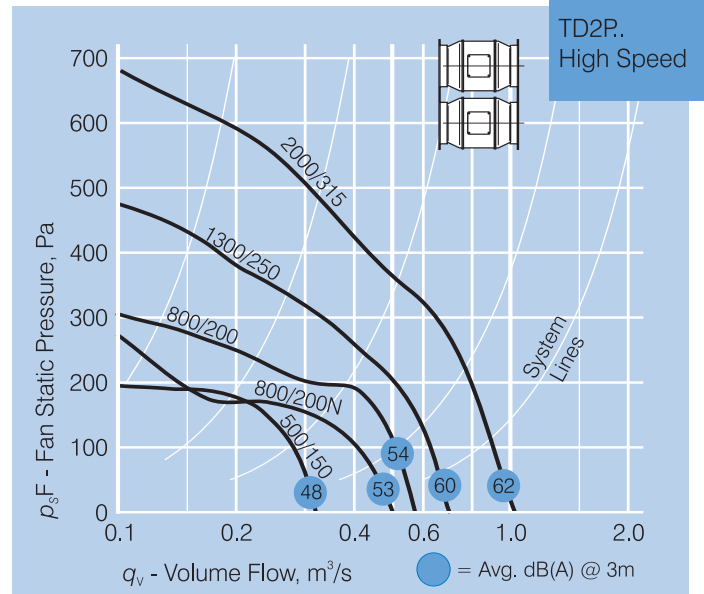

## Noise Data

Model Number TD2P..	Avg. dB(A) @ 3m	In-duct Sound Power Levels $L_w$ dB re 1pW							
		63	125	250	500	1k	2k	4k	8k
500/150	48	61	54	67	63	62	66	60	50
800/200N	53	66	61	74	70	69	68	64	54
800/200	54	66	66	73	69	71	71	68	56
1300/250	60	66	71	76	73	78	77	70	63
2000/315	62	70	76	78	77	80	78	71	64

The above curves relate to the performance of 2-fans in parallel. Should higher volumes be required or selections of fans in series, refer to the Fantech CD program or a sales representative.

## Dimensions

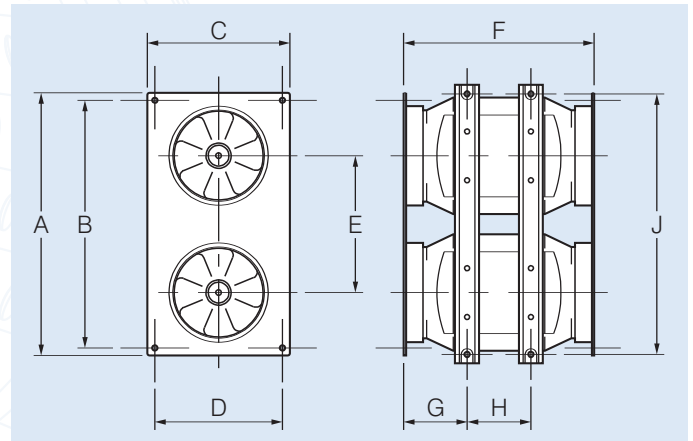

Model Number TD2P..	Dimensions, mm								
	A	B	C	D	E	F	G	H	J
500/150	395	375	220	200	206	310	110	80	417
800/200&N	440	420	240	220	225	317	103	100	456
1300/250	540	520	290	270	282	401	123	145	566
2000/315	690	650	355	335	347	451	136	182	699

We recommend fitting 2 off MCA shutters in parallel assemblies to eliminate short circuiting; these are not included in the dimensions shown.

## RED031-030 - REDUCER

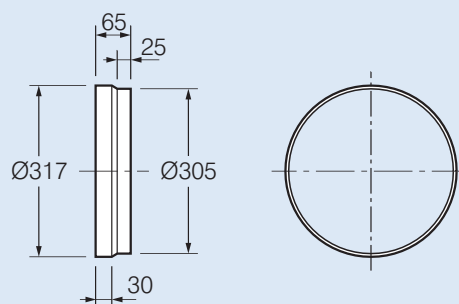

## TSS1-15 - 2-SPEED SWITCH

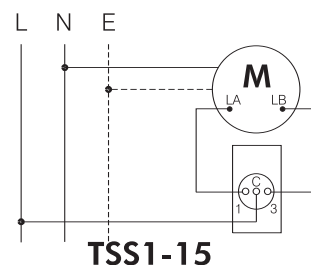

The TSS1-15 2-speed surface mounted switch has been specifically designed to suit the Mixvent range of fans.

Dimensions:- 70W x 114H  
A recess depth of 25 mm is required

**FANTECH**  
Intelligent Ventilation