

EZIFIT THRU ROOF SERIES - SUPPLY AIR



SUGGESTED SPECIFICATION





The roof ventilators shall be of the Ezifit Thru Roof supply air series as designed and manufactured by Fantech Pty Ltd.

The backward-curved centrifugal fans shall be direct-driven by continuous rated speed-controllable external rotor motors with manual-reset thermal protection.

They shall be constructed from galvanised steel, be suitable for tile and metal deck type roofs and include a 3-pin plug and lead.

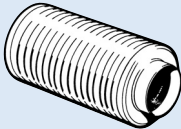
All models shall be fully tested as a complete assembled unit to ISO5801:2007 for air flow and ISO3744: 2010 for noise.

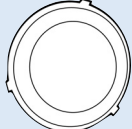
ANCILLARY EQUIPMENT

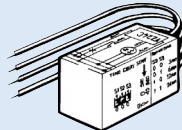
 CC - Circular attenuator Ref. H-16	 Backdraft dampers Ref. J-3	 Ceiling Grilles Ref. L-12/14
 VA - Speed controller Ref. M-5	 VZ - Run-on Timer Ref. M-14	

DESCRIPTION

The Ezifit Thru Roof supply air fan provides fresh filtered air to internal spaces and is suitable for tile or metal deck type roofs. It includes a high performance fan that makes it suitable for long duct runs and a multiple number of supply points. It produces low noise within the occupied space because the fan is mounted outside the building.

Typical Applications

Ideal for bringing fresh filtered air into homes office buildings, nursing homes, schools and day care centres.

Features

- Robust, galvanised steel construction.
- Fitted with a replaceable G2 dust filter.
- Suitable for tile and metal deck type roofs.
- Easy and simple to install.
- Comes with convenient 3-pin plug and lead.
- Powerful centrifugal fan allows it to provide air to a number of points/rooms.
- High quality 'Continuous Rated' motor.
- Speed-controllable with electronic controller.
- Powder coated finish is an optional extra.

Construction

Galvanised steel construction
Backward-curved centrifugal impellers
Duct support straps and removable dust filter included
Roof flashing piece included, specify roof type (tile or metal) at time of order

Motors

Type - external rotor, squirrel cage induction motor
Electricity supply - 230V, single-phase, 50/60Hz
Bearings - sealed-for-life, ball
Can be fitted with speed-controller
IP44 motor protection
See pages O-2/3 for details on these motors

Internal Thermal Protection

Manual reset protection is supplied as standard.

Testing

Air flow Tests to ISO5801:2007
Noise tests to ISO3744: 2010

TECHNICAL DATA

Model Number	Fan Speed rev/sec	Avg dB(A) @ 3m	ECE..S 1 ph. Watts	Amps	Approx weight kg
152#	41	51	110	0.51	9.5

Nominate roof flashing type: M=metal/deck roof, T=tile roof

HOW TO ORDER

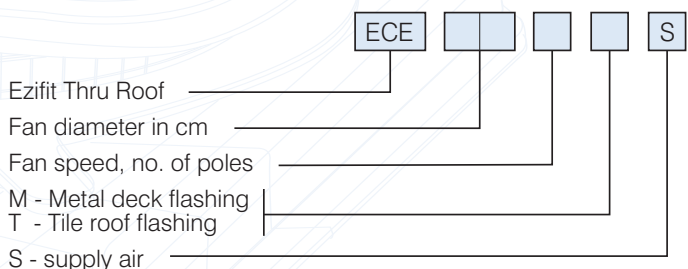

EZIFIT THRU ROOF SERIES - SUPPLY AIR

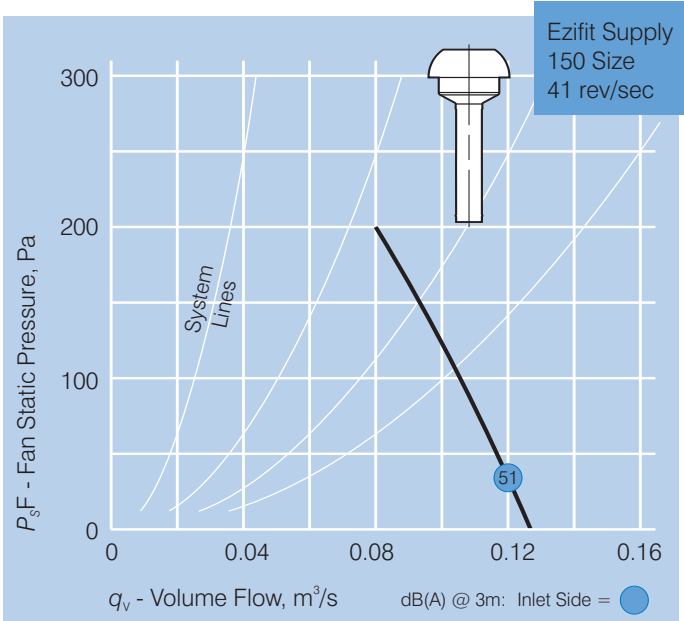

DIMENSIONS

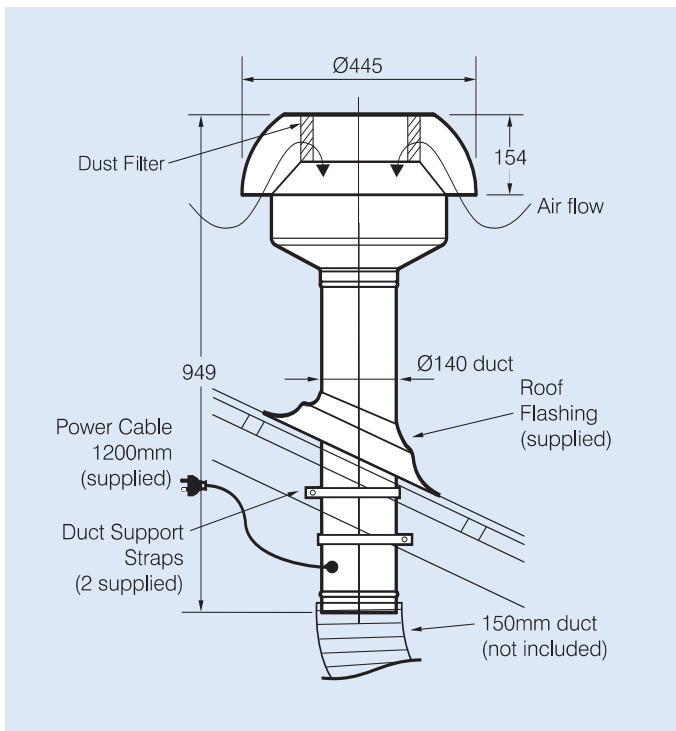

Scan the QR code to view more information online.

